

Cyber Pull Down User's Manual

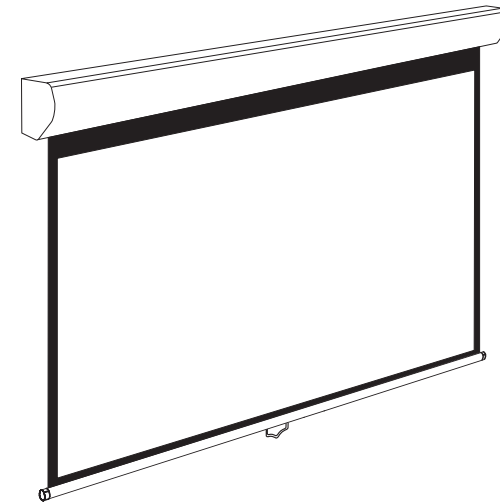

Model: CB-Pxx

Grandview Crystal Screen Canada Ltd.
#11- 3751 North Fraser Way,
Marine Way Business Centre,
Burnaby, BC, Canada V5J 5G4
Tel: 1-604-412-9777 Fax: 1-604-412-9796
Website: www.grandviewscreen.ca

Guangzhou Grandview Crystal Screen Co., Ltd.
P.O. 511400 Federal Ind. Zone No. 363, Yushan West Road,
Shiqiao, Panyu District, Guangzhou, Guangdong, China
Tel: +8620-8489-9499 Fax: +8620-8480-3343
Website: www.grandviewscreen.com



Thank you for purchasing a Grandview projection screen.

Before use, please read this manual carefully. After installation, keep this manual for future reference.

Description

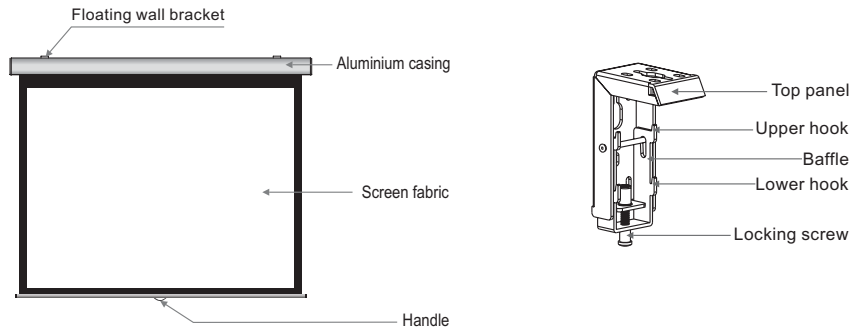

1

Accessories

- Floating wall bracket(2pcs)
- $\phi 5$ 40mm Tapping screw & cap (8sets)
- M5x10 Screw (6pcs)

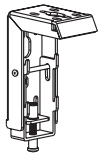

- Hanging bracket (2pcs)



- Instruction manual (1pc)

Warnings

- The warranty will only be valid if you follow the instructions below carefully! Improper use and care may cause serious injury and/or damage!
- Make sure the Fixing screw be fastened when using the wall bracket, to avoid any damage.
- Make sure the surface you have chosen for installing the screen is flat and secure.
- Please read the following as any damage to the screen surface will impact the image's quality:
 1. Do not touch the screen surface by hand.
 2. Do not write or draw on the screen surface.
 3. Do not poke the screen surface by finger or edge tools, as it may cause scratches or tears.
 4. Do not use any detergent or cleaning products to clean the screen surface, please clean it with a soft cloth and lukewarm water.
- Retract the screen after every use.
- Ensure the screen is level when it is wall-mounted installation, when the screen is spread, it should be balanceable with the wall.
- Do not pull two sides of the screen fabric by hands, do not fold the screen fabric.
- To prevent unnecessary damage, the operation and maintenance of the screen should be done by adult.



Ignoring the safety warnings may lead to injuries or damaging the product.



The screen should be installed at secure place to avoid any accidents or the screen falling down.



Retract the screen after every use. Leave it hanging for a long period may cause screen fabric loose



Please contact your local dealer for repair or maintenance, and contact us if you have any further questions. Avoid taking apart the fixtures by yourself. Loose parts may cause the screen fall down.



Avoid hanging anything on the screen as it may cause the screen to fall down.

Do not take apart and replace with unknown parts. If there are any problems, please contact your local dealer. Product specifications are subject to change.

6

Operation

1. Lowering the screen:

Using the pull down handle, lower the screen with a gentle even action until desired height is reached.

The screen will stop when it reaches its maximum.

DO NOT ATTEMPT TO FORCE THE SCREEN LOWER THAN THIS POINT.

The screen will retract slightly before lock-ing in place.

2. Raising the screen:

Using the handle, pull down the screen a small way, then allow the screen to raise quickly.

Caution: Do not let go of the handle until the screen is fully retracted. Damage from retracting too rapidly can occur. Do not allow the dropper bar to hit the screen case when retracting.

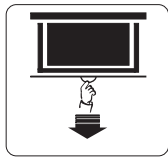

Picture 1

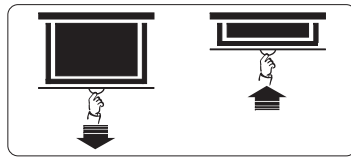

Picture 2

Installation

Take out all the parts from the packaging to ensure you have all necessary components.

There are three installation measures for this product, namely wall mount, ceiling mount and ceiling hang. The installed distance can be changeable up to your needs via adjusting the slipper block, while the ideal position is the mounting bracket is at its nearest point to the end cap, which can reduce unnecessary vibration or noise.

Wall and ceiling installation:

1. Mount the wall/ceiling brackets using the appropriate screws for your supporting material.
2. Ensure the brackets are horizontal and near the ends of the casing. Fasten to the wall or ceiling, not both. (Figure 1).

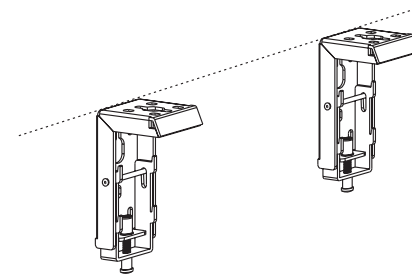

Figure 1

Installation Steps

- a) Wood supporting materials: Drill in the $\phi 5 \times 40$ screws through the appropriate holes in the bracket (Figure 2-3).
- b) Concrete supporting materials: Install the anchors and drill in the $\phi 5 \times 40$ screws into the appropriate bracket holes. (Figure 4-5).

Wood wall installation

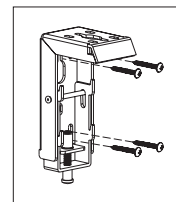

Figure 2

Wood ceiling installation

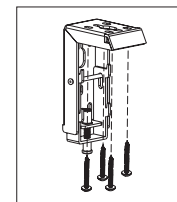

Figure 3

Concrete wall installation

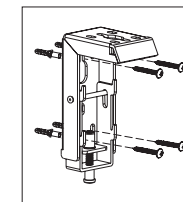

Figure 4

Concrete ceiling installation

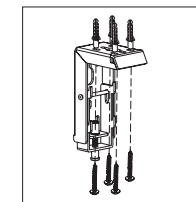
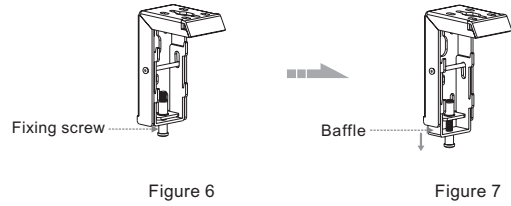
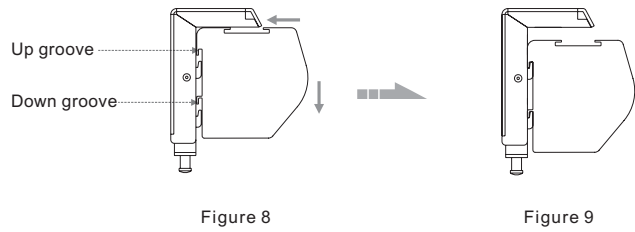

Figure 5

3. Loosen the locking screw to lower the bracket clamp all the way down. (Figure 6-7)



4. Mount the projection screen by sliding the casing grooves over the bracket hooks. (Figure 8-9)



5. Tighten the locking screw to clamp the screen securely in place. (Figure 10-11)

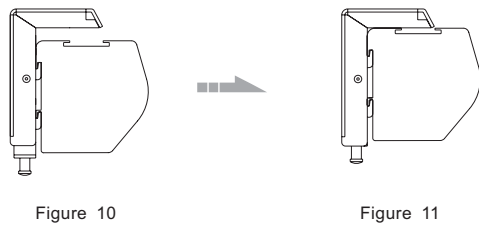

Ceiling hang installation

Each end of the screen casing needs to be supported by a hook (not provided). Ensure that the suspension system (cable and/or hook) can support the weight of the screen.

1. To drill two same holes with an electric drill horizontally with wall, then fasten hangers (unprovided) onto the ceiling. (Figure 12)

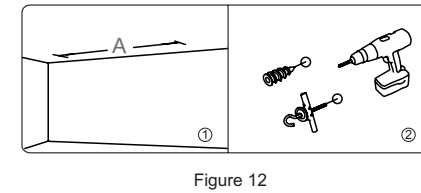

2. Use three M5x10mm screws to fasten the hanging brackets, to the wall and ceiling brackets as shown. (Figure 13-14)

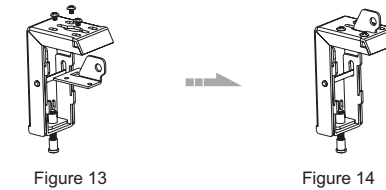

3. Attach the wall and ceiling brackets to the casing as shown in figures 15 and 16.

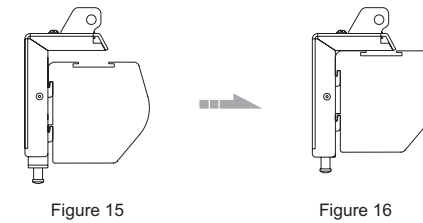

4. Place hooks through the hanging brackets to suspend the projection screen as shown. See figure 17.

